



Workmaster

Features

- Top quality versions of the basic workbench.
- Available with suspended or pedestal type cabinets.
- Worksurface materials include both ESD and standard laminates, maple block and stainless steel.
- Available with a full complement of ergonomic accessories and electrical supply options.



D
1

Workmaster
series

There is no such thing as “just” a workbench at IAC. We lavish the same top-quality materials and manufacturing techniques on these workbenches as we do on our top-of-the-line Dimension 4 workstations. The Workmaster Series offers a broad selection of easy-to-assemble workbenches for assembly, lab and technical environments. A wide variety of optional drawers, cabinets, adjustable shelving, fluorescent task lighting, mechanical and electrical components, and color choices allow endless customization.

Workbenches



Quality and attention to details are the hallmark of all IAC products. Note the steel ball bearing drawer slides and recessed handles used on all Workmaster Series drawers.



Ergonomic accessories, such as this fully adjustable footrest, make Workmaster Series workbenches comfortable and productive for all workers.

The Workmaster Series features a wide variety of electrical supply options. Choices include power strips mounted above or below the worksurface, and as shown here, many configurations of outlets and switches built into Instrument Shelf risers.



D
2

Workmaster
series



1 Product Selection

1. Select a Workmaster Series workbench based on your requirements.
2. Choose a part number based on size and worksurface type, standard laminate, ESD laminate.
3. Choose accessories to be included on selected workbench. Consider the Multi-Task System (See section H) or Instrument Shelves (See page D-24).
4. Choose a Basic Paint color. This color, in addition to the main workbench structure, will be used on any optional drawer and TE2 outer cases. See paint color selection on page A-15.
5. Contrast paint for drawer and accessories such as TE2 Front Face must be specified. Choose the contrast paint color from the paint selection and specify as "Contrast Color" on a separate line on your order.
6. Select a worksurface laminate color noting that Standard and ESD laminates have separate color choices and codes. See laminate color selection on page A-16.

With these items selected you are ready to write up the order.

Ordering your new Workmaster Series Workbench is easy!

The professional staff at IAC is ready to assist you in building the workbench that best fits your needs and application. To prevent errors and to speed order fulfillment, IAC recommends that you follow the steps outlined here when selecting, ordering and receiving products.

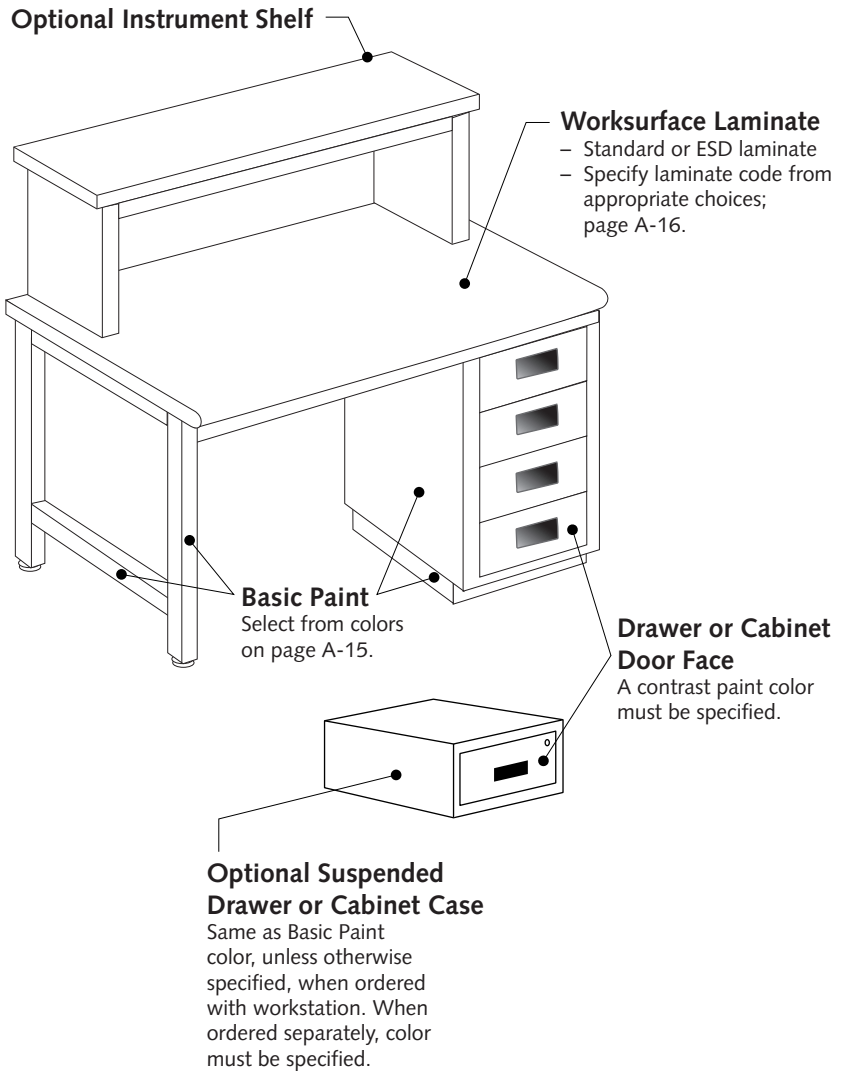



2 Product Orders

1. Workstations are delivered Knocked Down (KD) unless otherwise specified. Please refer to Terms and Conditions, page A-13, for additional assembly charges, and to page A-12 for Delivery Considerations.
2. Product Orders should be written with each workstation and its accessories grouped and fully specified before adding another workstation with different specifications. Please see example on right.

3 Product Receipt

IAC products are fully inspected before leaving the factory to assure full satisfaction. Should any claims develop that require product return it is important that certain steps be followed. Please review Receiving Shipments on page A-12 before opening shipments from IAC.

Example:

- EF Series Workbench with Standard Laminate worksurface

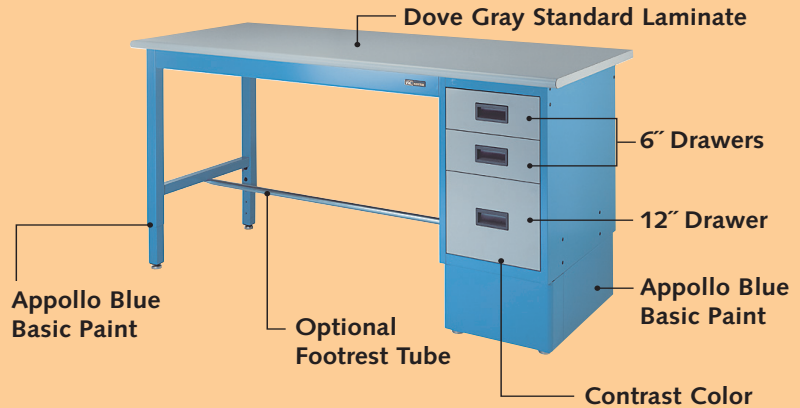

Order Sheet

Line No.	Part Number or Item Code	Description	Quantity
1	KD	Shipped as Knocked Down – Customer Assembled	
2	1000632	30" x 60" EF 30" H Series w/Standard Laminate	3
3	1021512	Footrest Tube (60" Bench/1 Pedestal)	3
4	A	Basic Paint Color: Appollo Blue	
5	06	Worksurface Laminate: Dove Gray	
6	H	Contrast: Appliance White	
7			
8	KD		
9	1020353	36" x 72" C Series Worksurface w/ESD Laminate	2
10	1050126	32" x 30" Pedestal (E-Left model)	2
11	1050246	32" x 30" Pedestal (P-Right model)	2
12	A	Basic Paint Color: Appollo Blue	
13	14	Worksurface Laminate: Nevamar White	
14	H	Contrast: Appliance White	
15			
		Continue grouping configurations as above for all workbenches in your order. Please call the factory with questions regarding order placement to avoid processing delays.	

Adjustable Height Workbenches

IAC

D
5



Model A

Adjustable height legs with Standard or ESD worksurfaces.

Floor Glides

Need a set of new leg extenders?

Part Number

1021653

The E Series unit shown here represents the most basic workbench of the Workmaster Series – four legs and a worksurface. Yet with numerous options offered, the E Series is extremely versatile. Using leg extenders, these workbenches are height adjustable from 30" to 36" in 2-inch increments. Weight capacity is 1,000 lbs. evenly distributed. The following pages show a variety of pre-configured E Series benches.

Model A – Adjustable Height Workbench

Length	Depth	Standard Laminate	ESD Laminate
48"	30"	1000001	1006001
	36"	1000011	1006011
60"	30"	1000002	1006002
	36"	1000012	1006012
72"	30"	1000003	1006003
	36"	1000013	1006013
96"	30"	1000005	1006005
	36"	1000015	1006015

Versatile E Series is Easily Expanded

...with a multitude of options such as Suspended Drawers and Cabinets, Instrument Shelves, Electrical and Air Service, Footrests and much more.







E Series Only Accessories begin on page D-13.

Instrument Shelves begin on page D-24.

Common Workmaster Accessories begin on page D-29.

Workmaster
Eseries

IAC Suspended Drawers – E Series Workbenches

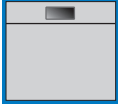





 Single 3" drawer 1050001	 Double 6" drawer 1050003	 Single 12" locker Left Hand 1050006	 Single 12" locker Right Hand 1050005
 Single 6" drawer 1050002	 Single 12" file drawer 1050004	 Triple drawer (3", 6", and 12" sections) 1050007	

All Drawer Depths = 20"







Locks are optional

Suspended Cabinets – E Series Workbenches



Left-Hand Cabinets

 Full 24" locker 1050016	 Double 6" drawer & 12" locker 1050022
 Double 12" locker 1050029	 Double 3" drawer & 18" locker w/shelf 1050024
 Single 6" drawer & 18" locker w/shelf 1050013	 Four 3" drawers & 12" locker 1050026

Right-Hand Cabinets

 Full 24" locker 1050015	 Double 6" drawer & 12" locker 1050021
 Double 12" locker 1050028	 Double 3" drawer & 18" locker w/shelf 1050023
 Single 6" drawer & 18" locker w/shelf 1050012	 Four 3" drawers & 12" locker 1050025

Drawers

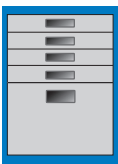
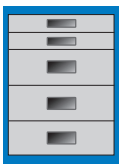
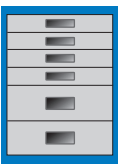
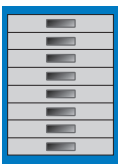
 Double 12" file drawer 1050019	 Double 6" drawer & 12" file drawer 1050014	 Four 6" drawers 1050011	 Four 3" drawers & 12" drawer 1050027
 Double 3" drawer, three 6" drawers 1050017	 Four 3" drawers, two 6" drawers 1050018	 Eight 3" drawers 1050020	

All Cabinet Depths = 20"

ordering tips from IAC...

Drawer and cabinet faces are painted a contrast color; please specify on order.

Options

Extra Locker Shelf
For use with full 18" and 24" locker only

1050031

Locking Mechanism
For gang locking cabinets

Mount	Part No.
Right-Hand	1050038
Left-Hand	1050034

Cylinder Lock
For individual drawers & cabinets

1050033

Master Key Set
*For individual drawers & cabinets

1050035

series



D
7

Workmaster
series

Pedestal Model ⁽¹⁾			D*		E – Right		E – Left		
			6" Drawers (4X)		6" Drawer (1X) 18" Locker (1X)		6" Drawer (1X) 18" Locker (1X)		
Finished Worksurface			Worksurface Laminate		Worksurface Laminate		Worksurface Laminate		
Height	Length	Depth ⁽²⁾	Standard	ESD	Standard	ESD	Standard	ESD	
30"	48"	30" (26")	1000391	1006391	1000471	1006471	1000551	1006551	
		36" (30")	1000401	1006401	1000481	1006481	1000561	1006561	
	60"	30" (26")	1000392	1006392	1000472	1006472	1000552	1006552	
		36" (30")	1000402	1006402	1000482	1006482	1000562	1006562	
	72"	30" (26")	1000393	1006393	1000473	1006473	1000553	1006553	
		36" (30")	1000403	1006403	1000483	1006483	1000563	1006563	
96"	30" (26")	1000395	1006395	1000475	1006475	1000555	1006555		
	36" (30")	1000405	1006405	1000485	1006485	1000565	1006565		
32"	48"	30" (26")	1000411	1006411	1000491	1006491	1000571	1006571	
		36" (30")	1000421	1006421	1000501	1006501	1000581	1006581	
	60"	30" (26")	1000412	1006412	1000492	1006492	1000572	1006572	
		36" (30")	1000422	1006422	1000502	1006502	1000582	1006582	
	72"	30" (26")	1000413	1006413	1000493	1006493	1000573	1006573	
		36" (30")	1000423	1006423	1000503	1006503	1000583	1006583	
96"	30" (26")	1000415	1006415	1000495	1006495	1000575	1006575		
	36" (30")	1000425	1006425	1000505	1006505	1000585	1006585		
34"	48"	30" (26")	1000431	1006431	1000511	1006511	1000591	1006591	
		36" (30")	1000441	1006441	1000521	1006521	1000601	1006601	
	60"	30" (26")	1000432	1006432	1000512	1006512	1000592	1006592	
		36" (30")	1000442	1006442	1000522	1006522	1000602	1006602	
	72"	30" (26")	1000433	1006433	1000513	1006513	1000593	1006593	
		36" (30")	1000443	1006443	1000523	1006523	1000603	1006603	
96"	30" (26")	1000435	1006435	1000515	1006515	1000595	1006595		
	36" (30")	1000445	1006445	1000525	1006525	1000605	1006605		
36"	48"	30" (26")	1000451	1006451	1000531	1006531	1000611	1006611	
		36" (30")	1000461	1006461	1000541	1006541	1000621	1006621	
	60"	30" (26")	1000452	1006452	1000532	1006532	1000612	1006612	
		36" (30")	1000462	1006462	1000542	1006542	1000622	1006622	
	72"	30" (26")	1000453	1006453	1000533	1006533	1000613	1006613	
		36" (30")	1000463	1006463	1000543	1006543	1000623	1006623	
96"	30" (26")	1000455	1006455	1000535	1006535	1000615	1006615		
	36" (30")	1000465	1006465	1000545	1006545	1000625	1006625		



Notes:

- (1) Reference only; order by part number.
- (2) Actual pedestal depth shown in parentheses.

*** Worksurfaces are pre-drilled and inserted to mount these types of pedestal cabinets on the right, unless otherwise specified.**

E Series Workbenches

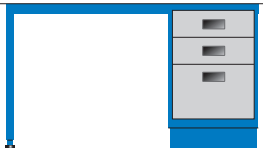
D
8

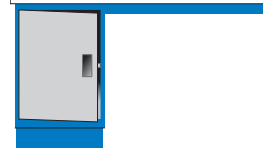
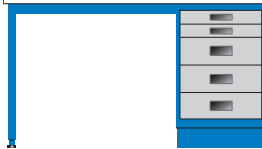
F *	H - Right	H - Left	I *
			
6" Drawer (2X) 12" Drawer (1X)	24" Locker w/Shelf (1X)	24" Locker w/Shelf (1X)	3" Drawer (2X) 6" Drawer (3X)

Worksurface Laminate		Worksurface Laminate		Worksurface Laminate		Worksurface Laminate	
Standard	ESD	Standard	ESD	Standard	ESD	Standard	ESD
1000631	1006631	1000711	1006711	1000791	1006791	1000871	1006871
1000641	1006641	1000721	1006721	1000801	1006801	1000881	1006881
1000632	1006632	1000712	1006712	1000792	1006792	1000872	1006872
1000642	1006642	1000722	1006722	1000802	1006802	1000882	1006882
1000633	1006633	1000713	1006713	1000793	1006793	1000873	1006873
1000643	1006643	1000723	1006723	1000803	1006803	1000883	1006883
1000635	1006635	1000715	1006715	1000795	1006795	1000875	1006875
1000645	1006645	1000725	1006725	1000805	1006805	1000885	1006885
1000651	1006651	1000731	1006731	1000811	1006811	1000891	1006891
1000661	1006661	1000741	1006741	1000821	1006821	1000901	1006901
1000652	1006652	1000732	1006732	1000812	1006812	1000892	1006892
1000662	1006662	1000742	1006742	1000822	1006822	1000902	1006902
1000653	1006653	1000733	1006733	1000813	1006813	1000893	1006893
1000663	1006663	1000743	1006743	1000823	1006823	1000903	1006903
1000655	1006655	1000735	1006735	1000815	1006815	1000895	1006895
1000665	1006665	1000745	1006745	1000825	1006825	1000905	1006905
1000671	1006671	1000751	1006751	1000831	1006831	1000911	1006911
1000681	1006681	1000761	1006761	1000841	1006841	1000921	1006921
1000672	1006672	1000752	1006752	1000832	1006832	1000912	1006912
1000682	1006682	1000762	1006762	1000842	1006842	1000922	1006922
1000673	1006673	1000753	1006753	1000833	1006833	1000913	1006913
1000683	1006683	1000763	1006763	1000843	1006843	1000923	1006923
1000675	1006675	1000755	1006755	1000835	1006835	1000915	1006915
1000685	1006685	1000765	1006765	1000845	1006845	1000925	1006925
1000691	1006691	1000771	1006771	1000851	1006851	1000931	1006931
1000701	1006701	1000781	1006781	1000861	1006861	1000941	1006941
1000692	1006692	1000772	1006772	1000852	1006852	1000932	1006932
1000702	1006702	1000782	1006782	1000862	1006862	1000942	1006942
1000693	1006693	1000773	1006773	1000853	1006853	1000933	1006933
1000703	1006703	1000783	1006783	1000863	1006863	1000943	1006943
1000695	1006695	1000775	1006775	1000855	1006855	1000935	1006935
1000705	1006705	1000785	1006785	1000865	1006865	1000945	1006945

Workmaster

series

Pedestal Benches - Cont.



D
9

Workmaster
series

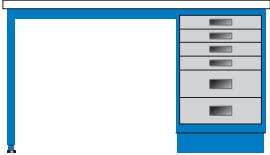
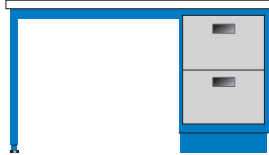
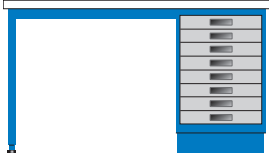
Pedestal Model ⁽¹⁾			J*		K*		M*	
								
			3" Drawer (4X) 6" Drawer (6X)		12" Drawer (2X)		3" Drawer (8X)	
Finished Worksurface			Worksurface Laminate		Worksurface Laminate		Worksurface Laminate	
Height	Length	Depth ⁽²⁾	Standard	ESD	Standard	ESD	Standard	ESD
30"	48"	30" (26")	1000951	1006951	1001031	1007031	1001111	1007111
		36" (30")	1000961	1006961	1001041	1007041	1001121	1007121
	60"	30" (26")	1000952	1006952	1001032	1007032	1001112	1007112
		36" (30")	1000962	1006962	1001042	1007042	1001122	1007122
	72"	30" (26")	1000953	1006953	1001033	1007033	1001113	1007113
		36" (30")	1000963	1006963	1001043	1007043	1001123	1007123
96"	30" (26")	1000955	1006955	1001035	1007035	1001115	1007115	
	36" (30")	1000965	1006965	1001045	1007045	1001125	1007125	
32"	48"	30" (26")	1000971	1006971	1001051	1007051	1001131	1007131
		36" (30")	1000981	1006981	1001061	1007061	1001141	1007141
	60"	30" (26")	1000972	1006972	1001052	1007052	1001132	1007132
		36" (30")	1000982	1006982	1001062	1007062	1001142	1007142
	72"	30" (26")	1000973	1006973	1001053	1007053	1001133	1007133
		36" (30")	1000983	1006983	1001063	1007063	1001143	1007143
96"	30" (26")	1000975	1006975	1001055	1007055	1001135	1007135	
	36" (30")	1000985	1006985	1001065	1007065	1001145	1007145	
34"	48"	30" (26")	1000991	1006991	1001071	1007071	1001151	1007151
		36" (30")	1001001	1007001	1001081	1007081	1001161	1007161
	60"	30" (26")	1000992	1006992	1001072	1007072	1001152	1007152
		36" (30")	1001002	1007002	1001082	1007082	1001162	1007162
	72"	30" (26")	1000993	1006993	1001073	1007073	1001153	1007153
		36" (30")	1001003	1007003	1001083	1007083	1001163	1007163
96"	30" (26")	1000995	1006995	1001075	1007075	1001155	1007155	
	36" (30")	1001005	1007005	1001085	1007085	1001165	1007165	
36"	48"	30" (26")	1001011	1007011	1001091	1007091	1001171	1007171
		36" (30")	1001021	1007021	1001101	1007101	1001181	1007181
	60"	30" (26")	1001012	1007012	1001092	1007092	1001172	1007172
		36" (30")	1001022	1007022	1001102	1007102	1001182	1007182
	72"	30" (26")	1001013	1007013	1001093	1007093	1001173	1007173
		36" (30")	1001023	1007023	1001103	1007103	1001183	1007183
96"	30" (26")	1001015	1007015	1001095	1007095	1001175	1007175	
	36" (30")	1001025	1007025	1001105	1007105	1001185	1007185	



Notes:

- (1) Reference only; order by part number.
- (2) Actual pedestal depth shown in parentheses.

* Worksurfaces are pre-drilled and inserted to mount these types of pedestal cabinets on the right, unless otherwise specified.

E Series Workbenches

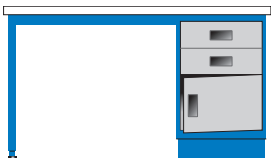
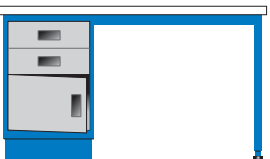
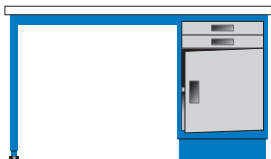
D
10

	N - Right		N - Left		O - Right		O - Left	
								
	6" Drawer (2X) 12" Locker (1X)		6" Drawer (2X) 12" Locker (1X)		3" Drawer (2X) 18" Locker w/Shelf (1X)		3" Drawer (2X) 18" Locker w/Shelf (1X)	
	Worksurface Laminate		Worksurface Laminate		Worksurface Laminate		Worksurface Laminate	
	Standard	ESD	Standard	ESD	Standard	ESD	Standard	ESD
	1001191	1007191	1001271	1007271	1001351	1007351	1001431	1007431
	1001201	1007201	1001281	1007281	1001361	1007361	1001441	1007441
	1001192	1007192	1001272	1007272	1001352	1007352	1001432	1007432
	1001202	1007202	1001282	1007282	1001362	1007362	1001442	1007442
	1001193	1007193	1001273	1007273	1001353	1007353	1001433	1007433
	1001203	1007203	1001283	1007283	1001363	1007363	1001443	1007443
	1001195	1007195	1001275	1007275	1001355	1007355	1001435	1007435
	1001205	1007205	1001285	1007285	1001365	1007365	1001445	1007445
	1001211	1007211	1001291	1007291	1001371	1007371	1001451	1007451
	1001221	1007221	1001301	1007301	1001381	1007381	1001461	1007461
	1001212	1007212	1001292	1007292	1001372	1007372	1001452	1007452
	1001222	1007222	1001302	1007302	1001382	1007382	1001462	1007462
	1001213	1007213	1001293	1007293	1001373	1007373	1001453	1007453
	1001223	1007223	1001303	1007303	1001383	1007383	1001463	1007463
	1001215	1007215	1001295	1007295	1001375	1007375	1001455	1007455
	1001225	1007225	1001305	1007305	1001385	1007385	1001465	1007465
	1001231	1007231	1001311	1007311	1001391	1007391	1001471	1007471
	1001241	1007241	1001321	1007321	1001401	1007401	1001481	1007481
	1001232	1007232	1001312	1007312	1001392	1007392	1001472	1007472
	1001242	1007242	1001322	1007322	1001402	1007402	1001482	1007482
	1001233	1007233	1001313	1007313	1001393	1007393	1001473	1007473
	1001243	1007243	1001323	1007323	1001403	1007403	1001483	1007483
	1001235	1007235	1001315	1007315	1001395	1007395	1001475	1007475
	1001245	1007245	1001325	1007325	1001405	1007405	1001485	1007485
	1001251	1007251	1001331	1007331	1001411	1007411	1001491	1007491
	1001261	1007261	1001341	1007341	1001421	1007421	1001501	1007501
	1001252	1007252	1001332	1007332	1001412	1007412	1001492	1007492
	1001262	1007262	1001342	1007342	1001422	1007422	1001502	1007502
	1001253	1007253	1001333	1007333	1001413	1007413	1001493	1007493
	1001263	1007263	1001343	1007343	1001423	1007423	1001503	1007503
	1001255	1007255	1001335	1007335	1001415	1007415	1001495	1007495
	1001265	1007265	1001345	1007345	1001425	1007425	1001505	1007505

Workmaster

series

Pedestal Benches - Cont.



D
11

Pedestal Model ⁽¹⁾			P - Right		P - Left		Q *		
			3" Drawer (4X) 12" Locker (1X)		3" Drawer (4X) 12" Locker (1X)		3" Drawer (4X) 12" Drawer (1X)		
Finished Worksurface			Worksurface Laminate		Worksurface Laminate		Worksurface Laminate		
Height	Length	Depth ⁽²⁾	Standard	ESD	Standard	ESD	Standard	ESD	
30"	48"	30" (26")	1001511	1007511	1001591	1007591	1001671	1007671	
		36" (30")	1001521	1007521	1001601	1007601	1001681	1007681	
	60"	30" (26")	1001512	1007512	1001592	1007592	1001672	1007672	
		36" (30")	1001522	1007522	1001602	1007602	1001682	1007682	
	72"	30" (26")	1001513	1007513	1001593	1007593	1001673	1007673	
		36" (30")	1001523	1007523	1001603	1007603	1001683	1007683	
96"	30" (26")	1001515	1007515	1001595	1007595	1001675	1007675		
	36" (30")	1001525	1007525	1001605	1007605	1001685	1007685		
32"	48"	30" (26")	1001531	1007531	1001611	1007611	1001691	1007691	
		36" (30")	1001541	1007541	1001621	1007621	1001701	1007701	
	60"	30" (26")	1001532	1007532	1001612	1007612	1001692	1007692	
		36" (30")	1001542	1007542	1001622	1007622	1001702	1007702	
	72"	30" (26")	1001533	1007533	1001613	1007613	1001693	1007693	
		36" (30")	1001543	1007543	1001623	1007623	1001703	1007703	
96"	30" (26")	1001535	1007535	1001615	1007615	1001695	1007695		
	36" (30")	1001545	1007545	1001625	1007625	1001705	1007705		
34"	48"	30" (26")	1001551	1007551	1001631	1007631	1001711	1007711	
		36" (30")	1001561	1007561	1001641	1007641	1001721	1007721	
	60"	30" (26")	1001552	1007552	1001632	1007632	1001712	1007712	
		36" (30")	1001562	1007562	1001642	1007642	1001722	1007722	
	72"	30" (26")	1001553	1007553	1001633	1007633	1001713	1007713	
		36" (30")	1001563	1007563	1001643	1007643	1001723	1007723	
96"	30" (26")	1001555	1007555	1001635	1007635	1001715	1007715		
	36" (30")	1001565	1007565	1001645	1007645	1001725	1007725		
36"	48"	30" (26")	1001571	1007571	1001651	1007651	1001731	1007731	
		36" (30")	1001581	1007581	1001661	1007661	1001741	1007741	
	60"	30" (26")	1001572	1007572	1001652	1007652	1001732	1007732	
		36" (30")	1001582	1007582	1001662	1007662	1001742	1007742	
	72"	30" (26")	1001573	1007573	1001653	1007653	1001733	1007733	
		36" (30")	1001583	1007583	1001663	1007663	1001743	1007743	
96"	30" (26")	1001575	1007575	1001655	1007655	1001735	1007735		
	36" (30")	1001585	1007585	1001665	1007665	1001745	1007745		

Notes:

- (1) Reference only; order by part number.
- (2) Actual pedestal depth shown in parentheses.

* Worksurfaces are pre-drilled and inserted to mount these types of pedestal cabinets on the right, unless otherwise specified.

E Series Workbenches

D
12

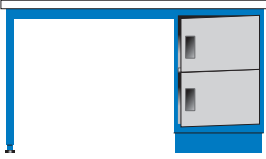
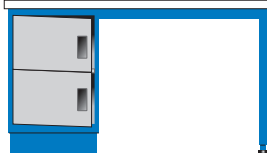
	R - Right	R - Left
		
	12" Locker (2X)	12" Locker (2X)

Worksurface Laminate		Worksurface Laminate	
Standard	ESD	Standard	ESD
1001751	1007751	1001831	1007831
1001761	1007761	1001841	1007841
1001752	1007752	1001832	1007832
1001762	1007762	1001842	1007842
1001753	1007753	1001833	1007833
1001763	1007763	1001843	1007843
1001755	1007755	1001835	1007835
1001765	1007765	1001845	1007845
1001771	1007771	1001851	1007851
1001781	1007781	1001861	1007861
1001772	1007772	1001852	1007852
1001782	1007782	1001862	1007862
1001773	1007773	1001853	1007853
1001783	1007783	1001863	1007863
1001775	1007775	1001855	1007855
1001785	1007785	1001865	1007865
1001791	1007791	1001871	1007871
1001801	1007801	1001881	1007881
1001792	1007792	1001872	1007872
1001802	1007802	1001882	1007882
1001793	1007793	1001873	1007873
1001803	1007803	1001883	1007883
1001795	1007795	1001875	1007875
1001805	1007805	1001885	1007885
1001811	1007811	1001891	1007891
1001821	1007821	1001901	1007901
1001812	1007812	1001892	1007892
1001822	1007822	1001902	1007902
1001813	1007813	1001893	1007893
1001823	1007823	1001903	1007903
1001815	1007815	1001895	1007895
1001825	1007825	1001905	1007905

Optional Multi-Task System



This optional upper structure provides a convenient method for adding lighting, shelves and other productivity accessories to any Workmaster workbench. Frame- or worksurface-mounted versions available.

See Section H for complete information.

Optional Instrument Shelf



IAC Instrument Shelves complete your technical work bench with extra surface area for instruments.

See page D-24 for complete information.

Workmaster series

Accessories & Upgrades

IAC Worksurface Upgrades and Replacements

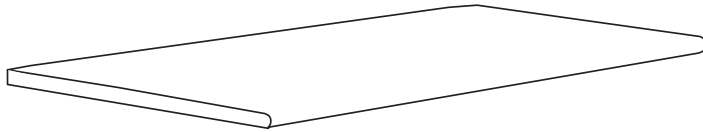

Worksurfaces are predrilled to accept all standard under-worksurface-mounted accessories.

For top-mounted accessories, such as instrument shelves or MTS, please consult factory.

Upgrade Worksurfaces

Length	Depth	Cleanroom Sealed	Stainless Steel	Maple
48"	30"	1020821	1020861	1020881
	36"	1020831	1020871	1020891
60"	30"	1020822	1020862	1020882
	36"	1020832	1020872	1020892
72"	30"	1020823	1020863	1020883
	36"	1020833	1020873	1020893
96"	30"	1020825	1020865	1020885
	36"	1020835	1020875	1020895

ordering tips from IAC...

Add Upgrade part number as a separate line item at time of original E Series Workbench order.

Replacement Worksurfaces

Length	Depth	Standard Laminate	ESD Laminate	Cleanroom Sealed	ESD Cleanroom Sealed	Stainless Steel	Maple
48"	30"	1020201	1020301	1020401	1020501	1020601	1020701
	36"	1020211	1020311	1020411	1020511	1020611	1020711
60"	30"	1020202	1020302	1020402	1020502	1020602	1020702
	36"	1020212	1020312	1020412	1020512	1020612	1020712
72"	30"	1020203	1020303	1020403	1020503	1020603	1020703
	36"	1020213	1020313	1020413	1020513	1020613	1020713
96"	30"	1020205	1020305	1020405	1020505	1020605	1020705
	36"	1020215	1020315	1020415	1020515	1020615	1020715

Metal Backsplash and End Stops

Supplied separately and installed by customer.

3 inches high above worksurface.

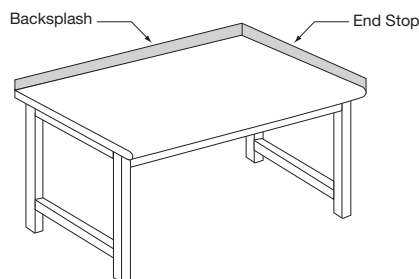

Backsplash

Worksurface Length	Part Number
48"	1021631
60"	1021632
72"	1021633
96"	1021635

End Stop

Worksurface Depth	Part Number*
30"	1021642
36"	1021643

*Sold as a set of two.

IAC E Series Accessories

Footrest Tubes

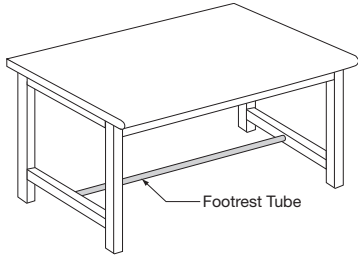

May be used alone as a footrest, or combined with our ERGO Footpans below for added comfort and fatigue reduction.

Bench Length	No Cabinets	Suspended Cabinets		Pedestal Cabinets	
		1 Cabinet	2 Cabinets	1 Cabinet	2 Cabinets
48"	1021501	1021521	N/A	1021511	N/A
60"	1021502	1021522	1021526	1021512	1021516
72"	1021503	1021523	1021527	1021513	1021517
96"	1021505	1021525	1021529	1021515	1021519

ERGO Footpans

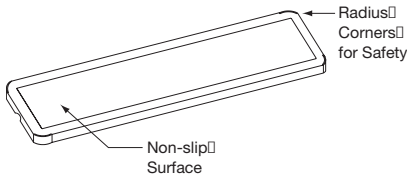

Adjustable by user for maximum convenience and versatility.

Footpan Length	Part Number
36"	1021621
24"	1021622
20" *	1021623

*For use between two suspended cabinets on 60" bench.

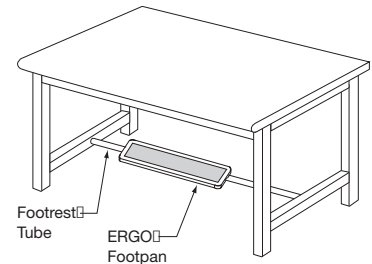

Lower Metal Shelves

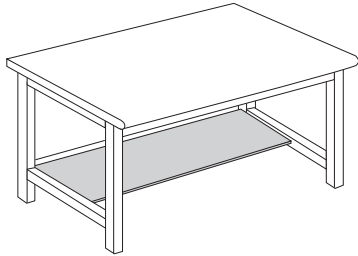

14" deep, these shelves provide added storage area conveniently located below the worksurface. Powder coat painted to match bench.

Bench Length	No Cabinets	Suspended Cabinets			Pedestal Cabinets	
		On Left	On Right	Dual	On Left	On Right
48"	1021541	1021591	1021581	N/A	1021561	1021551
60"	1021542	1021592	1021582	1021602	1021562	1021552
72"	1021543	1021593	1021583	1021603	1021563	1021553
96"	1021545	1021595	1021585	1021605	1021565	1021555

End Panels

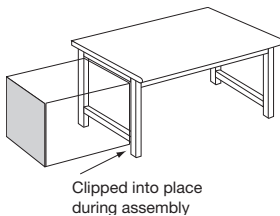

Metal End panels are powder coat painted to match bench.

Bench Depth	Part Number
30"	1021421
36"	1021422

Air Service

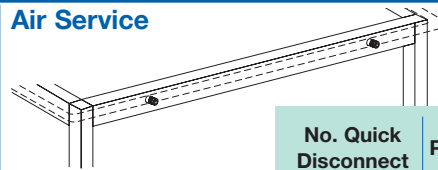

Air service is built into the front beam.

No. Quick Disconnect	Part Number
1	1021651
2	1021652

Leg Extenders

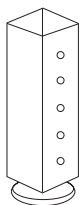

One set of four (4). Four positions; 6 inches of adjustment; 30", 32", 34" and 36".

Part Number
1021653

Modesty Panels

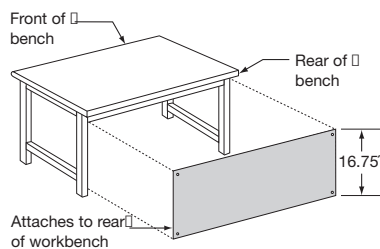

Bench Length	No. of Pedestal Cabinets on Bench		
	0*	1	2
48"	1021301	1021306	1021311
60"	1021302	1021307	1021312
72"	1021303	1021308	1021313
96"	1021305	1021310	1021315

*Select from this column for suspended cabinets and drawers

C Series Workbenches

IAC



Typical C Series workbench shown with multiple options.

“C” Series workbenches, with their multiple drawer and locker combinations, provide a solid foundation for several worksurface sizes as well as for enhanced functionality in lab or technical environments.

IAC also offers a wide variety of electrical and mechanical options, including ESD static-safe options, for optimal utilization.

Recommended for technical, laboratory and desk-type applications.

Features

- **1000 lb. Distributed Weight Support**
Delivers years of rugged use without sagging or warping.
- **Adjustable Floor Guides**
Accommodates uneven flooring.
- **Footrest Options**
Long lasting and ergonomically correct to reduce worker fatigue.
- **“Thread Insert” Attachment Points**
All joints are metal-to-metal for strength and high re-usability. Also makes assembly fast and easy.
- **Powder Coat Paint**
Durable, electrostatically-applied powder coat paint produces rugged exteriors.
- **Electrical/Mechanical Options**
Ensures that your “C” Series workbench will keep pace with your growing requirements.

To Order:

- 1 Select a worksurface from the tables below. Choose from worksurfaces with or without Instrument Shelf Mountings.

Basic Worksurfaces

Length	Depth	Worksurface Material					
		Standard Laminate	ESD Laminate	Standard Cleanroom	ESD Cleanroom	Stainless Steel	Maple
60"	30"	1020242	1020342	1020442	1020542	1020642	1020742
	36"	1020252	1020352	1020452	1020552	1020652	1020752
72"	30"	1020243	1020343	1020443	1020543	1020643	1020743
	36"	1020253	1020353	1020453	1020553	1020653	1020753
96"	30"	1020245	1020345	1020445	1020545	1020645	1020745
	36"	1020255	1020355	1020455	1020555	1020655	1020755

Worksurfaces with Instrument Shelf Mounting

Length	Depth	Worksurface Material					
		Standard Laminate	ESD Laminate	Standard Cleanroom	ESD Cleanroom	Stainless Steel	Maple
60"	30"	1020262	1020362	1020462	1020562	1020662	1020762
	36"	1020272	1020372	1020472	1020572	1020672	1020772
72"	30"	1020263	1020363	1020463	1020563	1020663	1020763
	36"	1020273	1020373	1020473	1020573	1020673	1020773
96"	30"	1020265	1020365	1020465	1020565	1020665	1020765
	36"	1020275	1020375	1020475	1020575	1020675	1020775







- 2 Choose two (Right and Left) pedestal models from selection shown on the next page. Be sure to specify which model is right and which is left when placing your order.
- 3 Turn the page and select your accessories. Choices include Instrument Shelves, Electrical Channels, Modesty Panels, Footrests, Isolation Screens, and more.







D
15



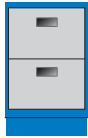

Workmaster
Series

C Series Workbenches

D
16

Pedestal Model ⁽¹⁾		D	E - Right	E - Left	F	H - Right	H - Left	I
								
Finished Worksurface:		6" Drawer (4x)	6" Drawer (1x) 18" Locker w/Shelf (1x)	6" Drawer (1x) 18" Locker w/Shelf (1x)	6" Drawer (2x) 12" Drawer (1x)	24" Locker w/Shelf (1x)	24" Locker w/Shelf (1x)	3" Drawer (2x) 6" Drawer (3x)
Height	Depth ⁽²⁾							
30"	30" (26")	1050101	1050111	1050121	1050131	1050141	1050151	1050161
	36" (30")	1050105	1050115	1050125	1050135	1050145	1050155	1050165
32"	30" (26")	1050102	1050112	1050122	1050132	1050142	1050152	1050162
	36" (30")	1050106	1050116	1050126	1050136	1050146	1050156	1050166
34"	30" (26")	1050103	1050113	1050123	1050133	1050143	1050153	1050163
	36" (30")	1050107	1050117	1050127	1050137	1050147	1050157	1050167
36"	30" (26")	1050104	1050114	1050124	1050134	1050144	1050154	1050164
	36" (30")	1050108	1050118	1050128	1050138	1050148	1050158	1050168

Pedestal Model ⁽¹⁾		J	K	M	N - Right	N - Left	O - Right	O - Left
								
Finished Worksurface:		3" Drawer (4x) 6" Drawer (2x)	12" Drawer (2x)	3" Drawer (8x)	6" Drawer (2x) 12" Locker (1x)	6" Drawer (2x) 12" Locker (1x)	3" Drawer (2x) 18" Locker w/Shelf (1x)	3" Drawer (2x) 18" Locker w/Shelf (1x)
Height	Depth ⁽²⁾							
30"	30" (26")	1050171	1050181	1050191	1050201	1050211	1050221	1050231
	36" (30")	1050175	1050185	1050195	1050205	1050215	1050225	1050235
32"	30" (26")	1050172	1050182	1050192	1050202	1050212	1050222	1050232
	36" (30")	1050176	1050186	1050196	1050206	1050216	1050226	1050236
34"	30" (26")	1050173	1050183	1050193	1050203	1050213	1050223	1050233
	36" (30")	1050177	1050187	1050197	1050207	1050217	1050227	1050237
36"	30" (26")	1050174	1050184	1050194	1050204	1050214	1050224	1050234
	36" (30")	1050178	1050188	1050198	1050208	1050218	1050228	1050238

Pedestal Model ⁽¹⁾		P - Right	P - Left	Q	R - Right	R - Left
						
Finished Worksurface:		3" Drawer (4x) 12" Locker (1x)	3" Drawer (4x) 12" Locker (1x)	3" Drawer (4x) 12" Drawer (1x)	12" Locker (2x)	12" Locker (2x)
Height	Depth ⁽²⁾					
30"	30" (26")	1050241	1050251	1050261	1050271	1050281
	36" (30")	1050245	1050255	1050265	1050275	1050285
32"	30" (26")	1050242	1050252	1050262	1050272	1050282
	36" (30")	1050246	1050256	1050266	1050276	1050286
34"	30" (26")	1050243	1050253	1050263	1050273	1050283
	36" (30")	1050247	1050257	1050267	1050277	1050287
36"	30" (26")	1050244	1050254	1050264	1050274	1050284
	36" (30")	1050248	1050258	1050268	1050278	1050288

ordering tips from IAC...

- 1 Be sure to order the correct depth cabinet for the depth of worksurface selected.
- 2 Order 26" deep cabinets for 30" deep worksurfaces. Order 30" deep cabinets for 36" deep worksurfaces.
- 3 See Lock options on page D-6

Notes:

(1) For reference only; order by part number.

(2) Actual pedestal depth shown in parentheses.

Workmaster series

IAC C Series Accessories

Footrest Tubes

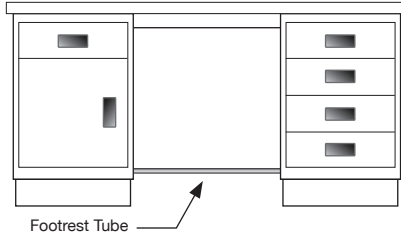

May be used alone as a footrest, or combined with our ERGO Footpans below for added comfort and fatigue reduction.

Bench Length	Part Number
60"	1021516
72"	1021517
96"	1021519

ERGO Footpans

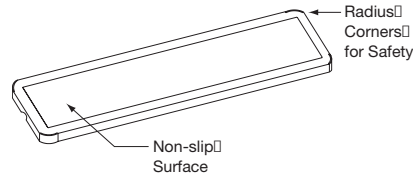
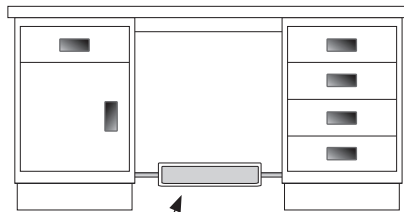

Adjustable by user for maximum convenience and versatility.

Footpan Length	Part Number
36" **	1021621
24"	1021622
20" *	1021623

* Use on 60" C Bench.

** Use on 96" C Bench only.

Lower Metal Shelves

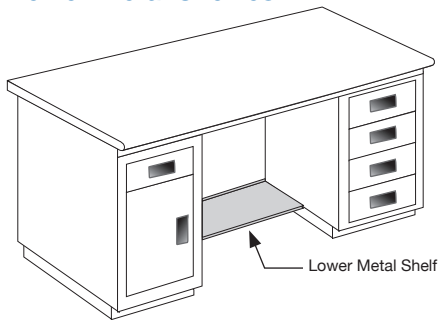

14" deep, these shelves provide added storage area conveniently located below the worksurface. Powder-coat painted to match bench.

Bench Length	Part Number
60"	1021572
72"	1021573
96"	1021575

Metal Backsplash and End Stops

Supplied separate and installed by customer.
3 inches high above worksurface.

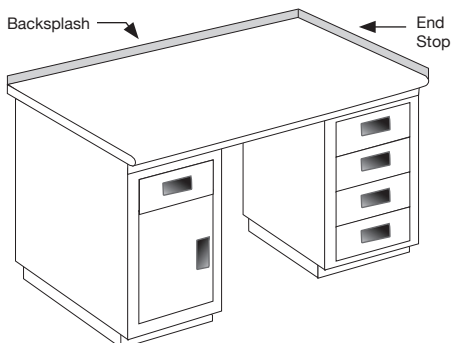

Backsplash

Worksurface Length	Part Number
48"	1021631
60"	1021632
72"	1021633
96"	1021635

End Stop

Worksurface Depth	Part Number*
30"	1021642
36"	1021643

*Sold as a set of two.

Modesty Panels

16.75" high.

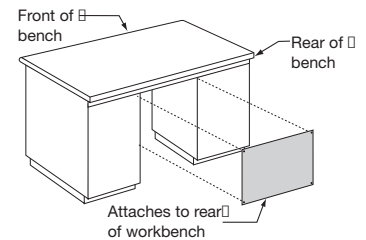

Bench Length	Part Number
48"	1021311
60"	1021312
72"	1021313
96"	1021315

Workmaster Storage Cabinet Workbenches



Features

- Massive Storage**
Almost 30" wide, the WSC pedestals deliver nearly double the storage of standard workbench pedestals.
- Built for the Big Jobs**
These benches support static loads up to 1000 lbs on a choice of worksurfaces that include standard or ESD plastic laminates, stainless steel, and maple block.
- Drawer Envy**
3", 6" and 12" drawer heights to choose from. All feature genuine Accuride™ steel ball bearing slides that extend 95% of full drawer depth.
- Choose Your Configuration**
Nine drawer configurations. Three overall bench lengths and two surface depths. Two worksurface heights.



IAC Industries answers the perpetual question, "Where do I put all this stuff?" with the new Workmaster™ Storage Cabinet Workbenches.

These units offer wide, large capacity drawer pedestals supporting a variety of worksurface options that include laminates, maple block and stainless steel. The main feature of this bench is the extra storage capacity that the cabinets give the you. It's rugged, sturdy and with the use of optional accessories can become an entire workcenter with added storage capacity.



Get Organized with Big Drawers

- Three drawer heights: 3", 6" and 12"
- Nine drawer configurations
- 100 lbs. weight capacity per drawer using Accuride® full ball-bearing, 95% extension drawer slides
- Optional drawer dividers
- Two black recessed handles in each drawer
- Optional ribbed rubber mat for drawer bottom
- Optional label holder



Have It Your Way...

- Lengths: 60", 72" and 96"
- Depths: 30" and 36"
- Two overall heights: 33" and 36"
- Order benches by components (cabinet(s), leg, work surface) so you can build it "your way"
- Worksurfaces are pre-drilled
- Supports 1,000 lbs distributed static load
- Worksurface available in standard and ESD laminate. Solid maple or stainless steel worksurfaces are also available



Customize as a Complete Work Center

- MTS I and II upright sets (worksurface mounted version only) and all MTS accessories
- Electrical channels
- Backsplash and end stops
- Modesty Panels
- End Panels



1 Product Selection

- Select an Workmaster workbench based on your requirements. Considerations include:
 - Overall length — choose from 60", 72" or 96" long worksurfaces (each available in either 30" or 36" depth).
 - Cabinet quantity and configuration — as many as three cabinets will fit, side-by-side, underneath a 96"L worksurface.
 - Drawer combinations — choose from nine different combinations of 3", 6" and 12" deep drawers
- Choose a part number based on size and worksurface type, standard laminate, ESD laminate.
- Choose accessories to be included on selected workbench. Consider the Multi-Task System (See section H) and Lower Metal Shelves (See page D-23).
- Choose Paint colors. Base color is used on main structural items. Contrast color is used on drawer fronts. These colors may be different or the same, but two colors must be specified. See paint color selection on page A-15.
- Select a worksurface laminate color noting that Standard and ESD laminates have separate color choices and codes. See laminate color selection on page A-16.

With these items selected you are ready to write up the order.

Ordering your new IAC Workmaster Storage Cabinet Workbench is easy! The professional staff at IAC is ready to assist you in building the workbench that best fits your needs and application. To prevent errors and to speed order fulfillment, IAC recommends that you follow the steps outlined here when selecting, ordering and receiving products.

96" Workbenches

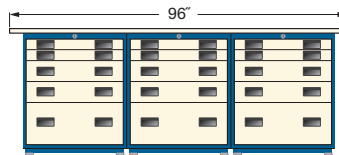

3 Cabinets

Each storage cabinet is 29.5" wide.

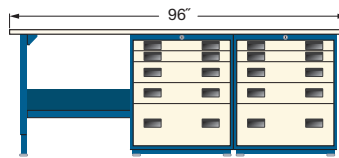

2 Cabinets + 1 Leg Assembly

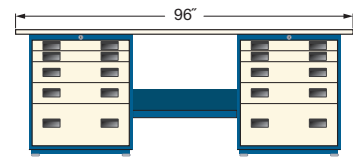

2 Cabinets

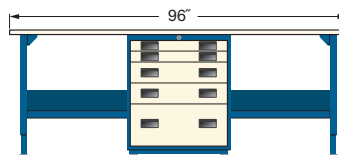

1 Cabinet + 2 Leg Assemblies

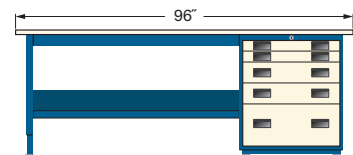

1 Cabinet + 1 Leg Assy. + Support Beam*

72" Workbenches

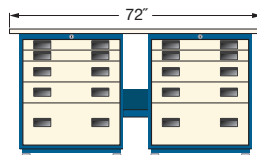

2 Cabinets

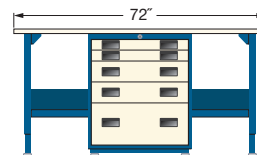

1 Cabinet + 2 Leg Assemblies

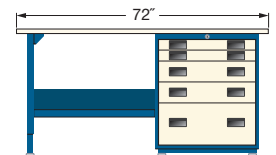

1 Cabinet + 1 Leg Assembly

60" Workbenches



2 Cabinets

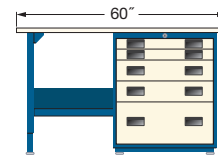

1 Cabinet + 1 Leg Assembly

*Support Beam is required only on 96" workbenches with a single storage cabinet and a single leg assembly.



2 Product Orders

1. Workstations are delivered Knocked Down (KD) unless otherwise specified. Please refer to Terms and Conditions, page A-13, for additional assembly charges, and to page A-12 for Delivery Considerations.
2. Product Orders should be written with each workstation and its accessories grouped and fully specified before adding another workstation with different specifications.
Please see example on right.

3 Product Receipt

IAC products are fully inspected before leaving the factory to assure full satisfaction. Should any claims develop that require product return it is important that certain steps be followed. Please review Receiving Shipments on page A-12 before opening shipments from IAC.

Example:

- *Workmaster Storage Cabinet Workbench, Maple Worksurface*
- *Length = 72"*
- *Depth = 36"*



D
20

Order Sheet

Line No.	Part Number or Item Code	Description	Quantity
1	KD	Shipped as Knocked Down – Customer Assembled	
2	1023673	36"D x 72"L Maple Worksurface	1
3	1055032	36"H Storage Cabinet – 2x3", 2x6" & 1x12" Drawers	1
4	1055101	Leg Assembly	1
5	1021803	Lower Shelf for 72"L, Single Cabinet Workbench	1
6	NB	Base Paint Color: Navy Blue	
7	M	Contrast Paint Color: Smooth Almond	
		Continue grouping configurations as above for all workbenches in your order. Please call the factory with questions regarding order placement to avoid processing delays.	

Workmaster series

Storage Cabinets

IAC Worksurfaces

Workmaster Storage Cabinet benches offer a great selection of worksurfaces, including ESD laminates, maple block, and stainless or painted steels. Ready to work? Go with Workmaster™!

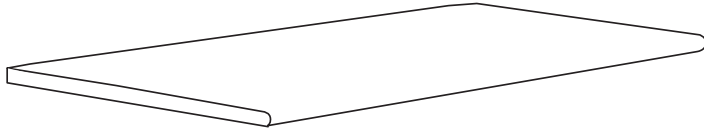

Length	Depth	Standard Laminate	ESD Laminate	Stainless Steel	Painted Steel	Maple Block
60"	30"	1023602	1023622	1023642	1023682	1023662
	36"	1023612	1023632	1023652	1023692	1023672
72"	30"	1023603	1023623	1023643	1023683	1023663
	36"	1023613	1023633	1023653	1023693	1023673
96"	30"	1023605	1023625	1023645	1023685	1023665
	36"	1023615	1023635	1023655	1023695	1023675

Leg Assembly

An end assembly that provides two legs to support the end of a worksurface in place of a pedestal cabinet. Legs are adjustable from 33" to 36" to match either pedestal height. Please specify paint color as separate line item.

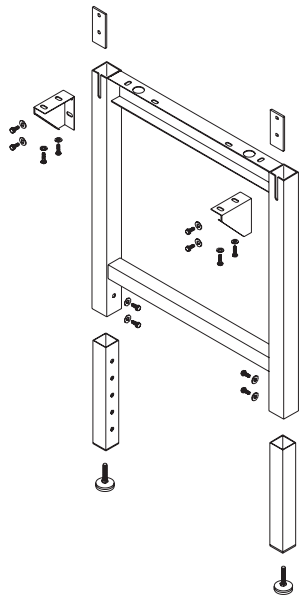

Part Number
1055101

Worksurface Support Beam Set

The Support Beam Set is required on 96" workbenches that use a single pedestal cabinet and a Leg Assembly to support each end of the worksurface. The beams provide rock-solid support for the span of worksurface between pedestal cabinet and leg assembly.

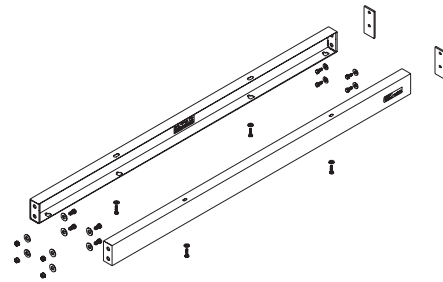

Workbench Configuration	Part Number
1 Cabinet	1055111
2 Cabinet	1055112

IAC Workmaster Storage Cabinets & Pedestals

All cabinets measure 33"H x 29.5"W x 26"D and differ only in their drawer combinations. Depending on how you configure your Workmaster Storage Cabinet bench you will select 1, 2 or 3 storage cabinets. Each Storage Cabinet used on a single bench may be a different model if desired — mix and match as you like!



Configuration	3" drawers (10X)	3" drawers (6X) 12" drawer (1X)	3" drawers (4X) 6" drawer (1X) 12" drawer (1X)	3" drawers (2X) 6" drawers (4X)	3" drawers (2X) 6" drawers (2X) 12" drawer (1X)
33" High	1055036	1055035	1055034	1055033	1055032
36" High	1055056	1055055	1055054	1055053	1055052

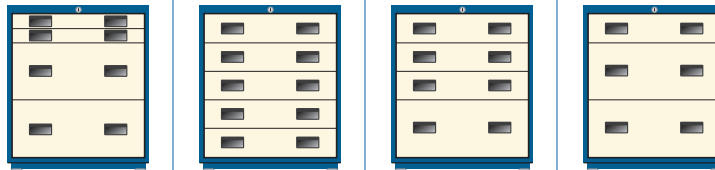

Configuration	3" drawers (2X) 12" drawers (2X)	6" drawers (5X)	6" drawers (3X) 12" drawer (1X)	6" drawers (1X) 12" drawers (2X)
33" High	1055031	1055023	1055022	1055021
36" High	1055051	1055043	1055042	1055041

Storage Cabinet Locking Mechanism

This gang-locking mechanism secures all drawers in the Storage Cabinet pedestal simultaneously. If not specified, the Storage Cabinets are shipped with no locking mechanism.

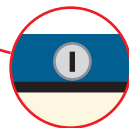
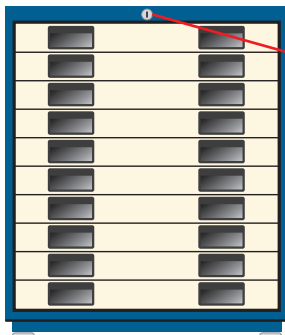

Part Number
1055009

Drawer Face Label Holder

Organize your drawers quickly and ergonomically. 1"H x 4"L size only. Self-adhesive backing. Label holder is only available in Clear. Manufactured with a "C" channel design that accommodates a 7/8" or 1" wide insert card or ticket. Changing inserts is as easy as removing, remarking and reinserting

Part Number
1055012

IAC Drawer Organizers

A place for everything, and everything in its place. You'll get a lot more value from the cavernous Workmaster Storage Cabinet drawers with these options that include V-Rib mats that cushion contents and reduce object roll, and dividers that sectionalize the large space for improved organization.

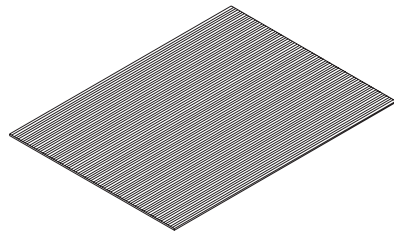

V-Rib Mat

Before dividing those drawers, lay down one of these cushioned v-rib mats. The mat's ridges help keep precious objects from rolling or sliding around during normal drawer use. Made of durable black elastomer.

Part Number
1055011

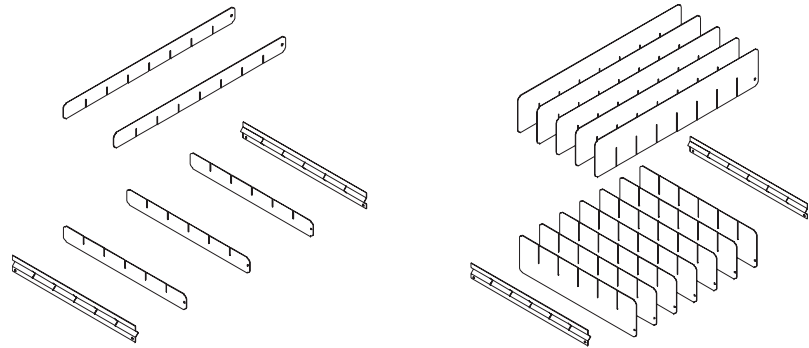

3" or 6" High Dividers

Steel dividers painted Black. Available in 12- or 48-section versions.

Sections	3" High		6" High	
	Divider Sets	Replacement Dividers	Divider Sets	Replacement Dividers
3" x 3" (48 sections)	1055001	1055005	1055002	1055007
6" x 6" (12 sections)	1055003	1055006	1055004	1055008

Lower Metal Shelves

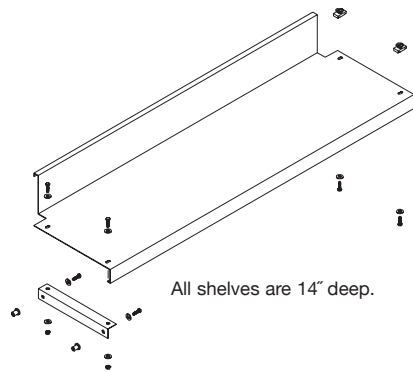

These lower metal shelves help keep clutter from stealing valuable worksurface area. Keep necessary items close at hand but out of the way. Built of heavy gauge steel and finished with durable powder coat paint. Please specify paint color. See paint color selection on page A-15.

Lower Shelf for 1 Cabinet Workbench

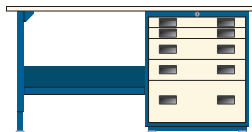

Worksurface Length	Part Number
60"	1021802
72"	1021803
96"	1021805

Lower Shelf for 2 Cabinet Workbench



Worksurface Length	Part Number
72"	1021813
96"	1021815

Lower Shelf for 1 Cabinet Split Workbench

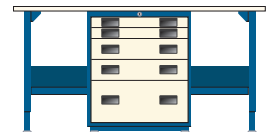

Worksurface Length	Part Number
60"	1021822
72"	1021823
96"	1021825

Each lower shelf is sold separately.

Instrument Shelves for E, C and Pro Series



Instrument Shelf shown mounted on a “C” Series workbench. Pictured with standard laminate shelf top, SE4 electrical riser, and upper bin holding panel.

IAC Instrument Shelves complete your technical workbench with extra surface area for equipment and instruments. Commonly used with “C” Series and “E” Series workbenches. “E” Series worksurfaces are pre-drilled to accept the Instrument Shelf when ordered simultaneously. IAC offers a wide variety of shelf material upgrades and electrical supply options for your Instrument Shelf, along with a Parts Cup Bin Panel to keep high usage components handy.

Select from a variety of lengths, heights and depths to fit all Workmaster Series workbenches and your working requirements.

ordering tips from IAC...

- 1 Please specify paint color if ordered separate from the workbench; otherwise paint is same as specified on workbench.
- 2 Review shelf surface upgrades before ordering. It's more economical to upgrade with original purchase than replacing the shelf later.

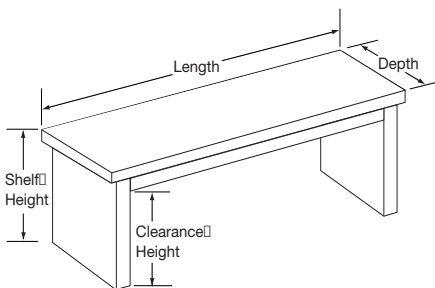

Shelf Height	Clearance Height	Length	Depth	Shelf Surface Material	
				Standard Laminate	ESD Laminate
18"	13.75"	48"	15"	1020001	1020101
			18"	1020011	1020111
		60"	15"	1020002	1020102
			18"	1020012	1020112
		72"	15"	1020003	1020103
			18"	1020013	1020113
21.25"	17.5"	48"	15"	1020091	1020191
			18"	1020121	1020221
		60"	15"	1020092	1020192
			18"	1020122	1020222
		72"	15"	1020093	1020193
			18"	1020123	1020223
24"	19.75"	48"	15"	1020031	1020131
			18"	1020041	1020141
		60"	15"	1020032	1020132
			18"	1020042	1020142
		72"	15"	1020033	1020133
			18"	1020043	1020143
96"	15"	1020035	1020135		
	18"	1020045	1020145		

IAC Electrical Service for Instrument Shelves – E, C, and Pro Series

All Instrument Shelf electrical upgrades are supplied with an 8 ft. power cord and 15-amp circuit breaker protection. Additional Electrical Accessories and upgrades are listed on the page opposite – please review before completing your order.

SE1 – Under Shelf Electrical

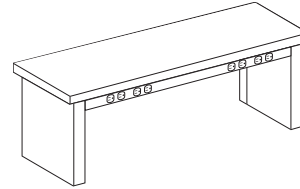

- 4 Duplex Outlets
- 15 Amps



Note: Channel can be positioned at the front (shown) or rear of the shelf.

Shelf Length

48"	60"	72"	96"
1022131	1022132	1022133	1022135

SE2 – Shelf Riser Electrical

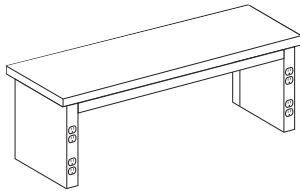

- 4 Duplex Outlets
– 2 in each riser
- 15 Amps



SE3 – Combination Shelf Electrical

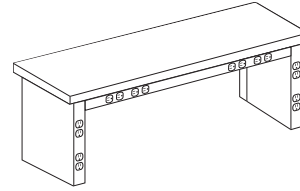

- 8 Duplex Outlets
– 2 in each riser
– 4 in under shelf channel
- 15 Amps



Shelf Height	Shelf Length			
	48"	60"	72"	96"
18"	1022141	1022142	1022143	1022145
21.25"	1022331	1022332	1022333	1022335
24"	1022261	1022262	1022263	1022265

Shelf Height	Shelf Length			
	48"	60"	72"	96"
18"	1022151	1022152	1022153	1022155
21.25"	1022341	1022342	1022343	1022345
24"	1022271	1022272	1022273	1022275

SE4 – Inside Riser Panel Electrical

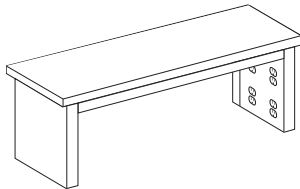

- Outlets and Controls Mounted on Inside Riser Panel
- Multiple Outlet Options
- Right-, Left-, or Both-Panel Installations
- SE 4 is 15 Amps and SE 4-3 is 20 Amps



Upgrade Code	Description	Riser Height					
		18"		21.25"		24"	
		Right	Left	Right	Left	Right	Left
SE 4	• 4 Duplex Outlets • 15 Amp Circuit Breaker*	1022161	1022162	1022167	1022168	1022163	1022164
SE 4-3	• 2 Duplex Outlets • 20 Amp Circuit Breaker • Ground Fault Interrupter • 1 Pilot Light On/Off Switch	1022191	1022192	1022197	1022198	1022193	1022194
SE 4-4	• 1 Duplex Outlet ⁽¹⁾ • 15 Amp Circuit Breaker • Pilot Light On/Off Switch	1022201	1022202	1022207	1022208	1022203	1022204
SE 4-5	• 2 Receptacles ⁽²⁾ • 20 Amp Circuit Breaker • For use with equipment requiring direct current • Pilot Light On/Off Switch	1022211	1022212	1022217	1022218	1022213	1022214

(1) NEMA 7-15R; 115V, 15 Amp, 400 Hz single phase
(2) NEMA 2-20R; 250 VDC, 20 Amp

* 15 amp circuit breaker pilot light switch

IAC Electrical Service for Instrument Shelves – E, C, and Pro Series

Instrument Shelf Electrical Upgrades

Contact your IAC Representative or Factory with questions about upgrading electrical service for Instrument Shelves.

Description		Part Number
Power Cord, 8 feet	15 Amp	1022301
	20 Amp	1022302
Pilot Light and Switch (Replaces one duplex outlet)	15 Amp	1022303
	20 Amp	1022304
Overload Circuit Breaker, 115V	15 Amp	1022305
	20 Amp	1022306
Extra Duplex Outlet	15 Amp	1022309
	20 Amp	1022310
Ground Fault Interrupter (Mounted in riser box cover)	15 Amp	1022308
	20 Amp	1022318
20 Amp Upgrade Kit (Includes all 20 Amp components, PC, wire, circuit breaker and outlets)	For SE1	1022314
	For SE2	1022315
	For SE3	1022316
	For SE4	1022317
Duplex 115V, 400Hz, Single Phase Receptacle		1022312
Ground Fault Interruptor, SE2 & SE3 Mounted (Replaces one 15 Amp duplex outlet)		1022313

Undershelf Lighting for Instrument Shelves



Good lighting is essential for productive work areas. These lights mount beneath the Instrument Shelf to keep the worksurface well illuminated. All units are supplied with an 8 ft. power cord and switch.

Length	Part Number
36"	1022321
48"	1022322

Note: 36" light is only to be used on 48" instrument shelves. All other size shelves use 48" light. Fluorescent tubes are not included.

ordering tips from IAC...

T8 lamp recommended.

IAC Instrument Shelf Accessories

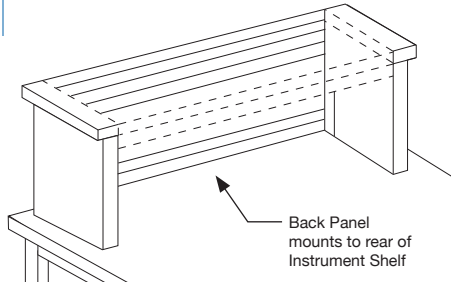

Upper Bin Holding Panel Illustrated

- Metal Isolation Screens – Economic Privacy
- Fabric Back Panels – Absorbs sound for additional privacy; mount documents with push pins. Includes Metal Isolation Screen as part of construction.
- Upper Bin Holding Panels – Accepts standard parts bin cups for convenient efficiency.

Upper Bin Holding Panel¹

Shelf Height	Panel Height	Shelf Length			
		48"	60"	72"	96"
18"	12"	1021341	1021342	1021343	1021345
21.25" and 24"	18"	1021351	1021352	1021353	1021355

Fabric Back Panels²

Shelf Height	TE-2 Mount ³	Shelf Length			
		48"	60"	72"	96"
18"	–	1021361	1021362	1021363	1021365
	yes	1021731	1021732	1021733	1021735
21.25"	–	1021681	1021682	1021683	1021685
	yes	1021831	1021832	1021833	1021835
24"	–	1021371	1021372	1021373	1021375
	yes	1021751	1021752	1021753	1021755

Conductive Fabric Back Panels²

Shelf Height	TE-2 Mount ³	Shelf Length			
		48"	60"	72"	96"
18"	–	1021381	1021382	1021383	1021385
	yes	1021761	1021762	1021763	1021765
21.25"	–	1021691	1021692	1021693	1021695
	yes	1021841	1021842	1021843	1021845
24"	–	1021391	1021392	1021393	1021395
	yes	1021781	1021782	1021783	1021785

Metal Isolation Screens²

Shelf Height	TE-2 Mount ³	Shelf Length			
		48"	60"	72"	96"
18"	–	1021321	1021322	1021323	1021325
	yes	1021701	1021702	1021703	1021705
21.25"	–	1021671	1021672	1021673	1021675
	yes	1021791	1021792	1021793	1021795
24"	–	1021331	1021332	1021333	1021335
	yes	1021721	1021722	1021723	1021725

Notes:

(1) Mounts inside Riser Box with Flange.

(2) Mounts to the back of the Riser Box.

(3) Use this option when a TE-2 Electrical Channel is mounted on the worksurface (page D-29).

IAC Instrument Shelf Upgrades and Replacements

Upgrade Shelves				
Length	Depth	Cleanroom Sealed	Stainless Steel	Maple
48"	15"	1021151	1022401	1022431
	18"	1021161	1022411	1022441
60"	15"	1021152	1022402	1022432
	18"	1021162	1022412	1022442
72"	15"	1021153	1022403	1022433
	18"	1021163	1022413	1022443
96"	15"	1021155	1022405	1022435
	18"	1021165	1022415	1022445

ordering tips from IAC...

1 Add Upgrade part number as a separate line item at time of original Instrument Shelf order.

Order STD shelf from page D-24.

2 Specify laminate color when ordering replacement shelves.

Replacement Shelf Surfaces							
Length	Depth	Standard Laminate	ESD Laminate	Cleanroom Sealed	ESD Cleanroom Sealed	Stainless Steel	Maple
48"	15"	1021001	1021031	1021061	1021091	1021211	1021241
	18"	1021011	1021041	1021071	1021101	1021221	1021251
60"	15"	1021002	1021032	1021062	1021092	1021212	1021242
	18"	1021012	1021042	1021072	1021102	1021222	1021252
72"	15"	1021003	1021033	1021063	1021093	1021213	1021243
	18"	1021013	1021043	1021073	1021103	1021223	1021253
96"	15"	1021005	1021035	1021065	1021095	1021215	1021245
	18"	1021015	1021045	1021075	1021105	1021225	1021255

Optional Multi-Task System



This optional upper structure provides a convenient method for adding lighting, shelves and other productivity accessories to any Workmaster Series workbench. Frame- or worksurface-mounted versions available.

See Section H for complete information.

IAC Common Electrical Services – E and C Series Workbenches

Electrical Channels

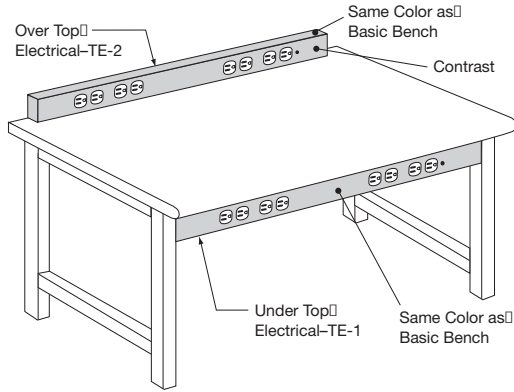

Workbench Length	UNDER Top Electrical – TE-1 ¹			OVER Top Electrical TE-2 ^{1,2}
	No Cabinets	1 Cabinet	2 Cabinets	
36"	—	—	—	1022129
48"	1022101	1022106	—	1022121
60"	1022102	1022107	1022111	1022122
72"	1022103	1022108	1022112	1022123
96"	1022105	1022110	1022114	1022125

Notes:

- (1) TE-1 and TE-2 Electrical Channels include: 15 amp breaker, 8 ft. molded power cord, mounting hardware and eight outlets.
- (2) If ordering with EZE Reach posts for your bench, TE-2 must be one size smaller than the workbench.

Electrical Channel Upgrades

Description	Part Number	
Power Cord, 8 ft.	15 Amp	1022301
	20 Amp	1022302
Pilot Light and Switch (Replaces one duplex outlet)	15 Amp	1022303
	20 Amp	1022304
Extra Duplex Outlet	15 Amp	1022309
	20 Amp	1022310
Ground Fault Interrupter	15 Amp	1022313
	20 Amp	1022319
TE1, TE2 20 Amp Upgrade Kit – Includes 8 ft. power cord; 20 Amp 115V overload circuit breaker; 20 Amp wire upgrade and 20-Amp Duplex Outlets	1022314	
Duplex, 115V, 400 Hz, Single Phase Receptacle	1022312	

ESD Accessories

Grounding Block

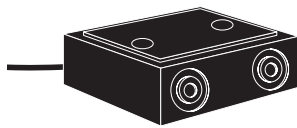

Attaches to workbench and is connected to ESD grounding lug on worksurface. Provides two receptacles for personal grounding devices, such as wrist straps. Includes ground cord.

Part Number

#6-6A

Personal Grounding Kit

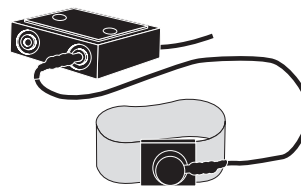

Includes:

- Grounding Block
- Wrist Strap
- Ground Cord

Part Number

PGK

Accessories



Caster Wheel Sets

Add mobility to Workmaster Series Workbenches with one of these caster sets.

These casters are upgrades only. Must be ordered at same time as bench.

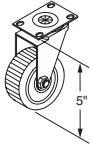

Medium Duty – 4" Workbench Caster Sets

- 4" hard rubber wheels
- Two locking, two non-locking, all swivel wheels per set
- 750 lbs. maximum

Workbench Series	Description	Workbench		Part Number	
		Depth	Height		
E Series	XX – Adjustable Height Model EA only	30"	30" to 36"	1050501	
		36"	30" to 36"	1050502	
	Fixed Height Single Pedestal Cabinet	30"	31"	1050521	
			32"	1050522	
			34"	1050523	
			36"	1050524	
		36"	31"	1050525	
			32"	1050526	
	C Series	Fixed Height Dual Pedestal Cabinets	30"	34"	1050527
				36"	1050528
				31"	1050541
				32"	1050542
36"			34"	1050543	
			36"	1050544	
			31"	1050545	
			32"	1050546	
		34"	1050547		
		36"	1050548		

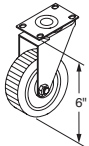

Heavy Duty – 5" Workbench Caster Sets

- 5" non-marking wheels
- Two locking, two non-locking, all swivel wheels per set
- 1000 lbs. maximum

Workbench Series	Description	Workbench		Part Number	
		Depth	Height		
E Series	XX – Adjustable Height Model EA only	30"	30" to 36"	1050511	
		36"	30" to 36"	1050512	
	Fixed Height Single Pedestal Cabinet	30"	32"	1050531	
			34"	1050532	
		36"	36"	1050533	
			32"	1050534	
	C Series	Fixed Height Dual Pedestal Cabinets	30"	34"	1050535
				36"	1050536
32"				1050551	
36"			34"	1050552	
			36"	1050553	
			32"	1050554	
		34"	1050555		
		36"	1050556		